

REGENCY NSF BLACK EPOXY WIRE SHELVING

Regency Space Solutions is your source for quality, affordable wire shelving. Offering a large selection of NSF Listed wire shelves and posts, Regency Space Solutions gives you the freedom to create the perfect shelving unit at the perfect price.

Black Epoxy-Coated Zinc Plated Wire Shelving

Black epoxy-coated zinc plated wire shelving is ideal for moist and humid environments that would otherwise lead to rapid corrosion of the metal surface. It's suitable for use in all environments, including:

- Dry storage
- Garage storage
- Personal storage
- Retail
- Walk-in coolers
- Warewashing areas

Quick Assembly

Regency Space Solutions' NSF Listed wire shelving is easy to assemble using split sleeves. Simply snap two split sleeves around each wire post to keep shelves level every time. Use the incrementally notched lines to help you install a level shelf. Each wire shelf comes complete with (4) pairs of split sleeves (eight total split sleeves).

Air Flow

Wire shelving offers unparalleled air flow between and around products thanks to its wire design.

Versatility

Regency Space Solutions' wire shelving offers the rigidity of solid metal with the adjustability of plastic. No tools or hardware required. Simply move the split sleeves up or down the posts for quick, efficient change.

Weight Capacity

- Each shelf up to 48" in length: 600 lbs.
- Longer shelves above 54" in length: 450 lbs.



- Zinc plated wire with black epoxy coating
- NSF Listed

REGENCY NSF BLACK EPOXY WIRE SHELVING

Item #	Width x Length (in.)	Weight
460EB1424	14 x 24	5.40 lbs.
460EB1430	14 x 30	6.39 lbs.
460EB1436	14 x 36	7.50 lbs.
460EB1442	14 x 42	8.49 lbs.
460EB1448	14 x 48	9.48 lbs.
460EB1460	14 x 60	12.24 lbs.
460EB1472	14 x 72	14.11 lbs.
460EB1824	18 x 24	6.06 lbs.
460EB1830	18 x 30	7.17 lbs.
460EB1836	18 x 36	8.27 lbs.
460EB1842	18 x 42	9.37 lbs.

Item #	Width x Length (in.)	Weight
460EB1848	18 x 48	10.58 lbs.
460EB1860	18 x 60	13.45 lbs.
460EB1872	18 x 72	15.87 lbs.
460EB2424	24 x 24	7.61 lbs.
460EB2430	24 x 30	8.93 lbs.
460EB2436	24 x 36	10.36 lbs.
460EB2442	24 x 42	11.79 lbs.
460EB2448	24 x 48	12.35 lbs.
460EB2460	24 x 60	17.86 lbs.
460EB2472	24 x 72	21.83 lbs.

REGENCY NSF BLACK EPOXY POSTS

Includes Feet:

Item #	Length (in.)	Weight
460EBP8	8	0.61 lbs.
460EBP14	14	0.80 lbs.
460EBP34	34	1.40 lbs.
460EBP64	64	2.39 lbs.
460EBP74	74	2.63 lbs.
460EBP86	86	3.10 lbs.

For Use with Casters:

Item #	Length (in.)	Weight
460EBPC8	8	0.61 lbs.
460EBPC14	14	0.80 lbs.
460EBPC34	34	1.40 lbs.
460EBPC64	64	2.39 lbs.
460EBPC74	74	2.63 lbs.
460EBPC86	86	3.10 lbs.



Wire Diameter

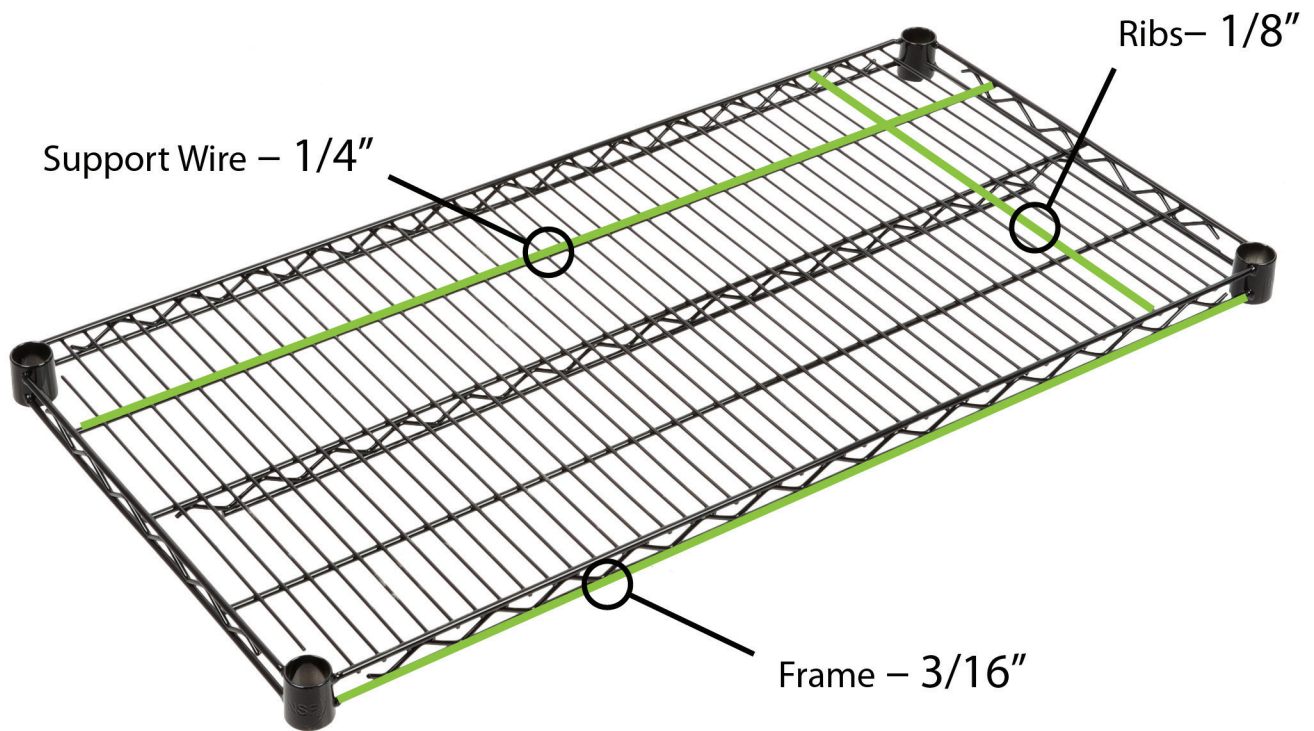

Wall Mounting Bracket Set

As part of the Regency Space Solutions' wire shelving collection, this deep wall mounting bracket is designed to mount one Regency Space Solutions black epoxy wire wall shelf. They feature a 1/4" diameter epoxy coated steel wire for maximum durability and strength. Ideal for use in humid or damp environments.

- NSF Listed

Item #	Length x Width (in.)	Weight
460BBI4X	14 x 2 ³ / ₄	2.04 lbs.

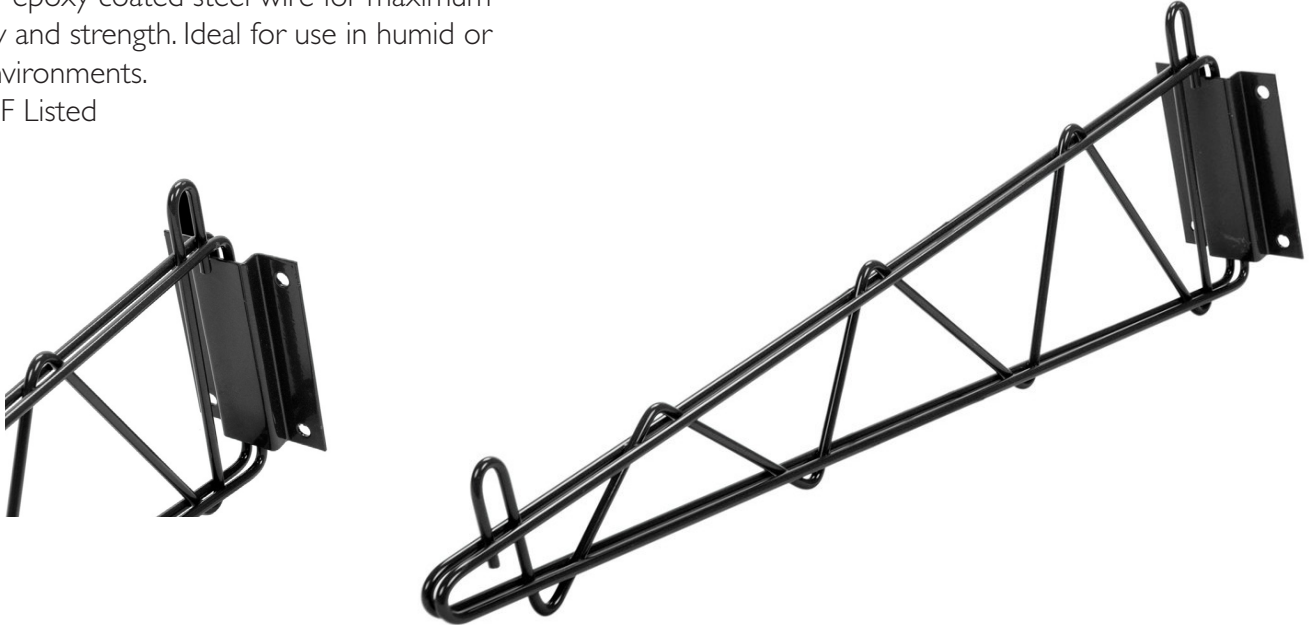

Double Wall Mounting Brackets for Adjoining Shelving

As part of the Regency Space Solutions' wire shelving collection, these deep wall mounting brackets are designed to adjoin two Regency Space Solutions black epoxy wire shelves for wall mounting. They feature a 1/4" diameter epoxy coated steel wire for maximum durability and strength. Ideal for use in humid or damp environments.

- NSF Listed

Item #	Length x Width (in.)	Weight
460BDBI4X	14 x 2 ³ / ₄	4.08 lbs.

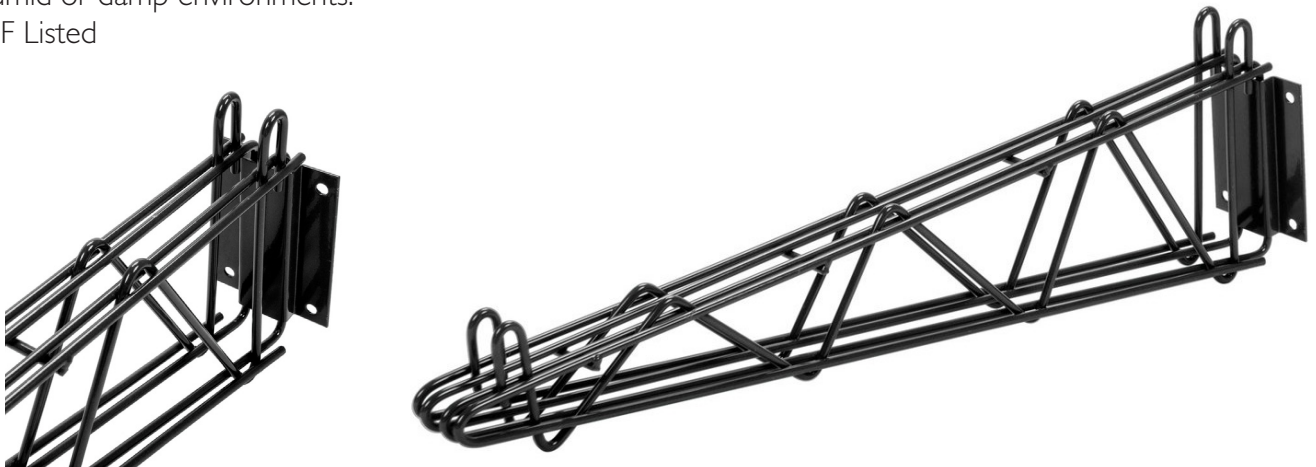

Shelf Dividers

- Item #460EBI4DVDR
- Dimensions: 14" x 8"
- Weight: 1.12 lbs.

This Regency black epoxy shelf divider allows you to quickly and easily organize the contents of your shelving unit. It is 8" high and made of durable chrome wire to easily separate cleaning supplies, boxes, or other loose items.

- NSF Listed

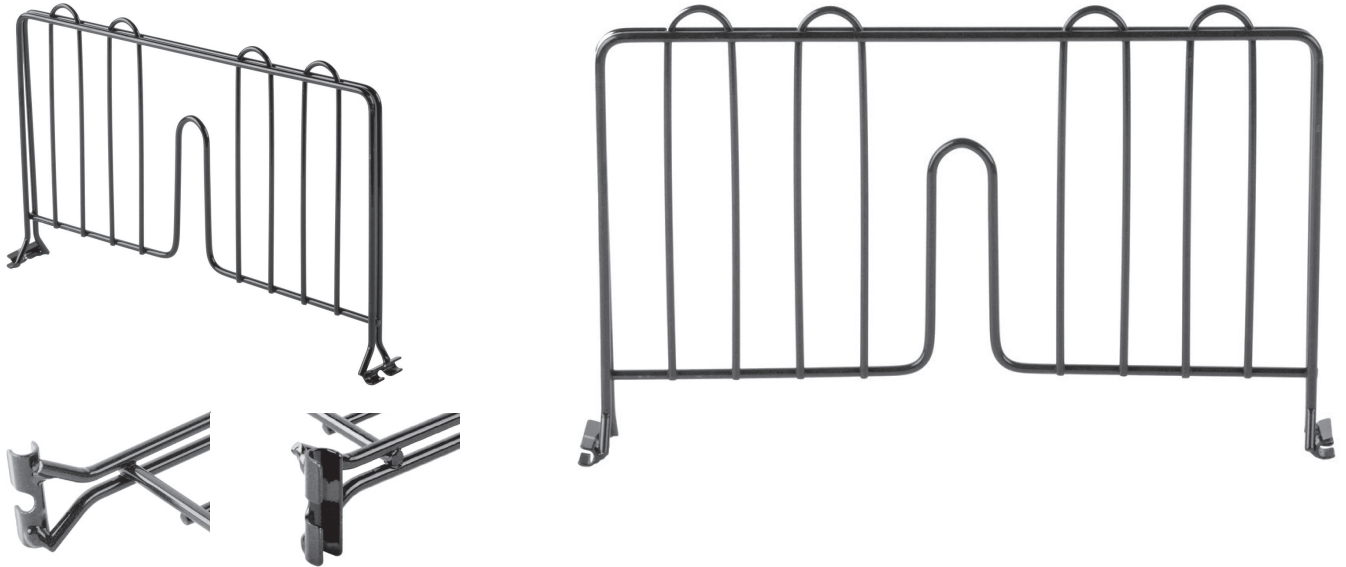

Shelf Ledges

- Item #460EBI4LDG
- Dimensions: 14" x 4"
- Weight: 0.69 lbs.

This Regency black epoxy shelf ledge is designed to easily install onto your wire shelving unit. Its 4" height is perfect for helping to contain items on a shelf and prevent them from falling off, whether you have cleaning supplies, boxes, or other loose items. Ledges are stackable to create a higher wall if needed.

- NSF Listed

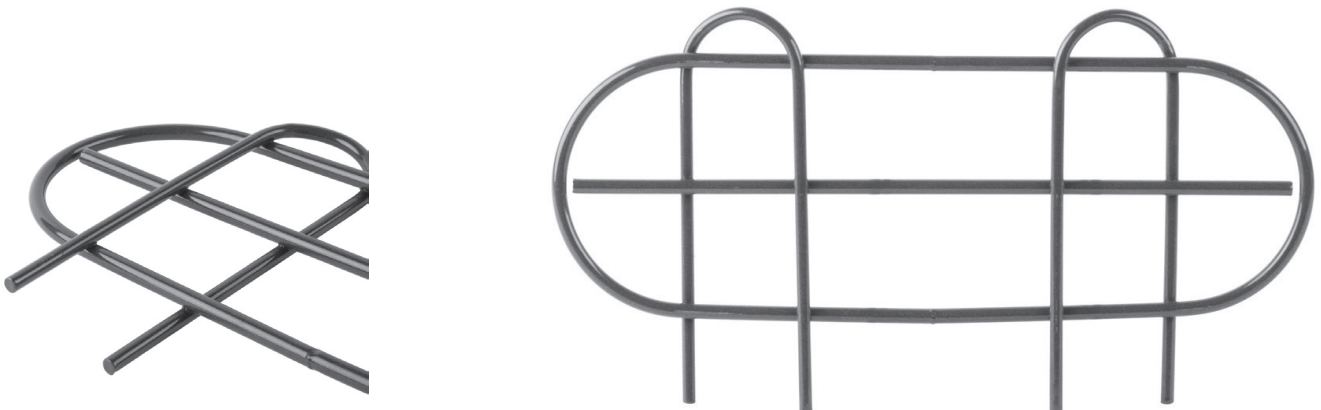

“S” Hook

- Item #4619995Z
- Weight: 0.07 lbs.
- Stainless Steel construction, not coated

“S” hooks allow you to install side by side shelves with fewer posts. Two “S” hooks are required per shelf for proper use.



Post Clamp

- Item #460ECPCLAMP
- Weight: 0.11 lbs.
- Chrome, not coated

Post clamps should be used to connect two posts together for greater side-by-side stability.



Post Foot Plate

- Item #460ECPFOOT
- Weight: 0.09 lbs.
- Chrome, not coated

Anchor your shelving unit to the floor by securing it in place with a foot plate.

- Simply screw one foot plate into the end of each post and fasten to the floor.



Casters

- Available in either rubber or polyurethane varieties.

Polyurethane

- Item #4615MPX (Non-Braking)
 - Weight: 2.03 lbs.
- Item #4615MPBX (Braking)
 - Weight: 2.26 lbs.
- Item #460EC26 (4 Pack)

Polyurethane casters glide quietly over everything from concrete and carpet, cracks, and cords.

- Soft, yet resilient material.
- Provides ample cushioning to protect loads and floors.

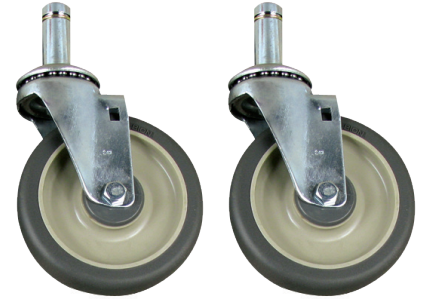

Rubber

- Item #359PLCB5140
 - Weight: 2.69 lbs.
- Item #460EC25 (4 Pack)

Rubber casters work well on rough, oily, or greasy floors.

- Provides quiet movement, good floor protection, and low initial roll movement.
- Will not crack with heavy loads.

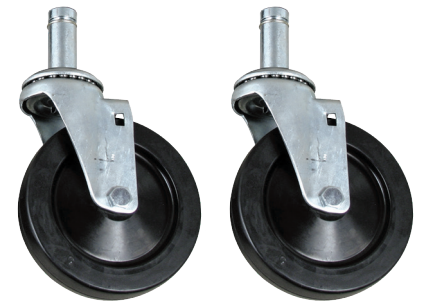

Heavy Duty Rubber Donut Bumpers

- Item #460RUBRDONT3 - 3½"
 - Weight: 0.36 lbs.
- Item #460RUBRDONT5 - 5½"
 - Weight: 0.90 lbs.

Protect your valuable shelving, equipment, and more with these heavy duty rubber donut bumpers! These bumpers are designed to fit Regency carts and posts above your casters so your walls, doors, and other products are safe during collisions.



Shelf Mat Overlays

Use these Regency shelf mat overlays to create a smooth, solid surface over your wire shelving! Made of clear PVC, this shelf mat overlay keeps small items from falling through your open grid shelves and can even help prevent damage to items on lower shelves by containing leaks, drips, and spills. These shelf mat overlays are easily removable for thorough cleaning and for when you need to convert your shelf back to an open grid.

Item #	Width x Length (in.)	Weight
460MATCLI424	14 x 24	0.72 lbs.
460MATCLI436	14 x 36	1.23 lbs.
460MATCLI448	14 x 48	1.36 lbs.
460MATCLI824	18 x 24	0.89 lbs.
460MATCLI836	18 x 36	1.31 lbs.
460MATCLI848	18 x 48	1.73 lbs.
460MATCLII860	18 x 60	2.22 lbs.
460MATCL2424	24 x 24	1.22 lbs.
460MATCL2436	24 x 36	1.78 lbs.
460MATCL2460	24 x 60	2.95 lbs.



Label Holders

Add pricing labels to your shelves, or keep your stock room or storage area neatly organized with the help of these clear or gray label holders! These holders easily snap on to your wire shelf so that all you have to do is insert the label.

Item #	Length (in.)	Color
460LABLC3IN	3 x 1	Clear
460LABLC6IN	6 x 1	Clear
460LABLC13IN	13 x 1	Clear
460LABLC19IN	19 x 1	Clear
460LABLC25IN	25 x 1	Clear
460LABLC31IN	31 x 1	Clear
460LABLC43IN	43 x 1	Clear
460LABLC55IN	55 x 1	Clear

Item #	Length (in.)	Color
460LABLG6IN	6 x 1	Gray
460LABLG13IN	13 x 1	Gray
460LABLG19IN	19 x 1	Gray
460LABLG25IN	25 x 1	Gray
460LABLG43IN	43 x 1	Gray
460LABLG55IN	55 x 1	Gray
4619990P	3 x 1 1/4	Gray
460LH	3 x 1 9/16	White



Shelving Warranty Information



Regency Space Solutions NSF epoxy wire shelving is guaranteed to be free from defect in material and construction at the time of shipment. Regency Space Solutions will replace a defective piece for a period of up to one year from the original date of installation, provided they have been properly installed and maintained. Regency Space Solutions is liable to replace the defective piece, but under no circumstances will pay any labor or subsequent damage.

Green and black epoxy finish shelves are covered under warranty against rust formation over more than five percent of the shelving surface up to the fifth year of the original installation.

Chrome finish shelves are covered under warranty against rust formation over more than five percent of the shelving surface up to the first year of the original installation in a dry application. Further, chrome finish shelves are not covered under warranty in any wet application, including but not limited to coolers and freezers.

All shelving is NSF Listed.